

DIANFLEX[®]

...simili a nessuno.



NOVITÀ
NOVITÀ

20
19

nuovi arrivi 2019



codice **101-86..**

VASCHE NOVELLINI



Una



Vogue



Venus



101-8601		VASCA ANGOLARE SIMMETRICA SEMICIRCOLARE UNA				
	Subcode	Misura/Colore	Conf.	Imb.	Euro	NewSubCode
	HY	cm 135 x 135 Vasca Hydro	1		2.341,11	
	ST	cm 135 x 135 Vasca con telaio	1		1.207,86	
Vasca con telaio e pannelli. Finitura vasca bianco lucido. Con colonna di scarico.						
101-8620		VASCA ANGOLARE ASIMMETRICA SEMICIRCOLARE VOGUE				
	Subcode	Misura/Colore	Conf.	Imb.	Euro	NewSubCode
	HYDX	165x85 dx vasca Hydro	1		2.341,11	
	HYSX	165x85 sx vasca Hydro	1		2.341,11	
	HYRDX	165x85 dx Hydro c/Rubinetteria	1		2.856,23	
	HYRSX	165x85 sx Hydro c/Rubinetteria	1		2.856,23	
	STDX	cm 165 x 85 dx vasca c/telaio	1		1.207,86	
	STSX	cm 165 x 85 sx vasca c/telaio	1		1.207,86	
Vasca con telaio e pannelli. Finitura vasca bianco lucido. Con colonna di scarico. Per gli ingombri consultare la scheda tecnica.						
101-8625		VASCA ANGOLARE VENUS				
	Subcode	Misura/Colore	Conf.	Imb.	Euro	NewSubCode
	177HYDX	170x70 dx Hydro	1		2.341,11	
	177HYSX	170x70 sx Hydro	1		2.341,11	
	177STDX	170x70 dx con telaio	1		1.207,86	
	177STSX	170x70 sx con telaio	1		1.207,86	
Vasca con telaio e pannelli. Finitura vasca bianco lucido. Con colonna di scarico. Per gli ingombri consultare la scheda tecnica.						

UNA

VASCA ANGOLARE SIMMETRICA SEMICIRCOLARE

Misure		Capacità	Codice	Scelta struttura			
Cm	H	lt.		Colonna di scarico	Con telaio	1 pannello	
							

STANDARD CON TELAIO								
135 x 135	55	190	101-8601-ST	X			X	X

HYDRO CON TELAIO SENZA DISINFEZIONE									
135 x 135	55	190	101-8601-HY	X			X	X	



FINITURA
VASCA



Bianco
lucido



FUNZIONI E DOTAZIONI

(disponibili a seconda dell'allestimento)



Massaggio corpo Whirpool (6 jets) aria/acqua con regolazione di tempo e intensità manuale o automatica. Per soddisfare qualsiasi esigenza di benessere.



Colonna di scarico



UNA

UNA

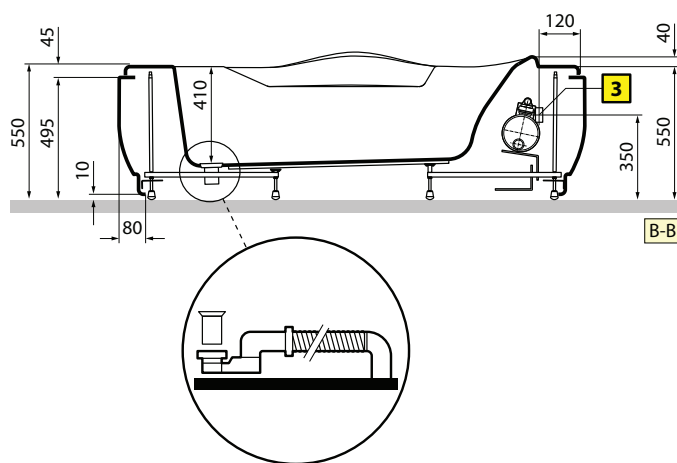
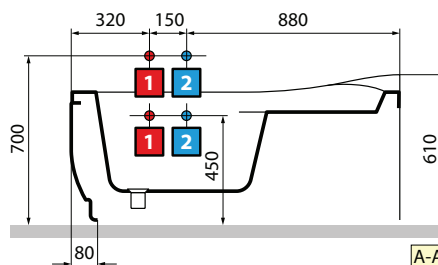
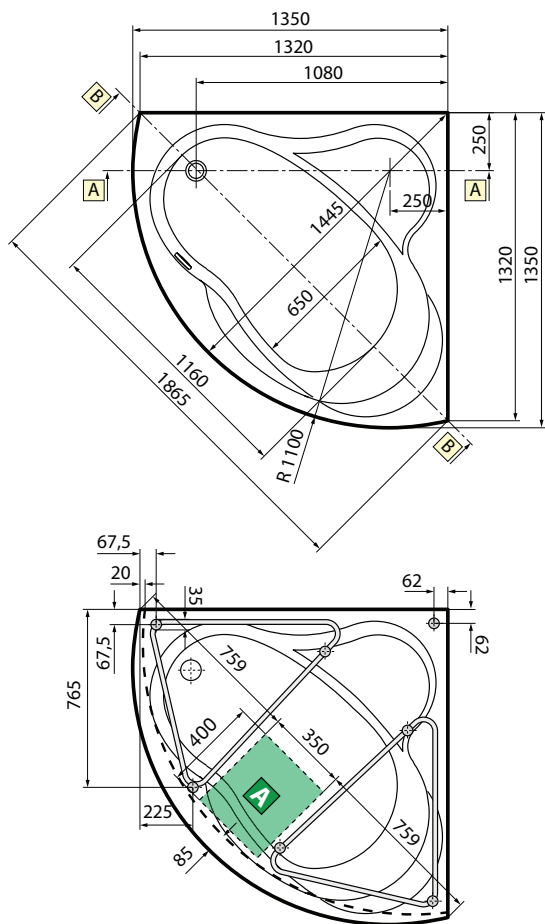

Capacità litri
190

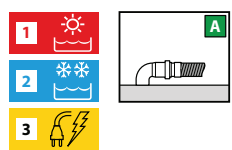

ATTENZIONE!
Può essere dannoso ai portatori di pacemakers

Installare a monte dell'apparecchio un interruttore differenziale da 30mA provvisto di interruttore onnipolare con apertura minima dei contatti ≥ 3 mm.

CARATTERISTICHE IDRAULICHE
6 bocchette whirlpool

Allaccio sifone con raccordo 1 1/2"

CARATTERISTICHE ELETTRICHE
Tensione 220-230 V
Frequenza 50 Hz
Potenza massima assorbita: 950 W
Whirlpool: 550 W



FINITURA
VASCA



Bianco
lucido



FUNZIONI E DOTAZIONI

(disponibili a seconda dell'allestimento)



Massaggio corpo Whirpool (6 jets) aria/acqua con regolazione di tempo e intensità manuale o automatica. Per soddisfare qualsiasi esigenza di benessere.



Pannello di controllo con funzioni Hydro sequence



Poggiatesta in materiale antibatterico



Colonna di scarico



VOGUE

VOGUE

VERSIONE SINISTRA

VERSIONE DESTRA

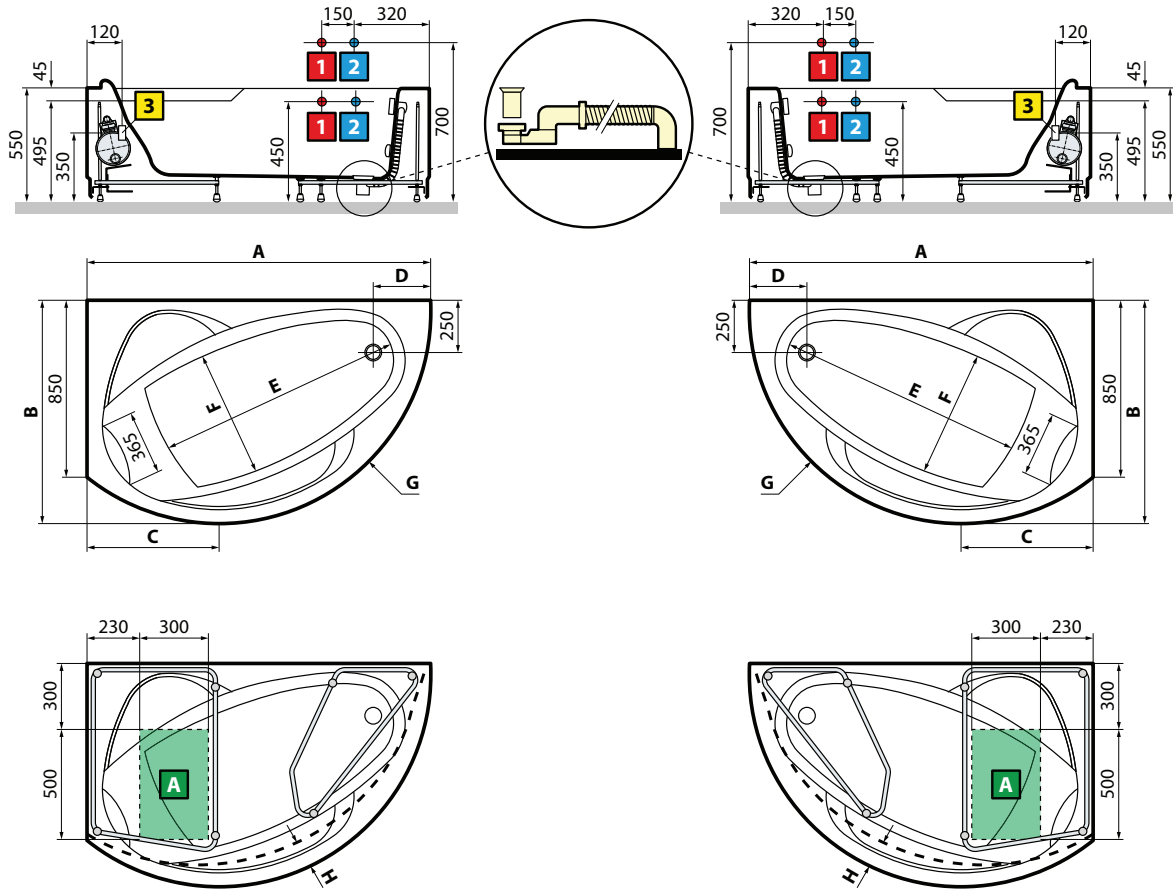

modello	A	B	C	D	E	F	G	H	Capacità litri
165x85	1650	1070	630	280	1150	640	1015	155	180

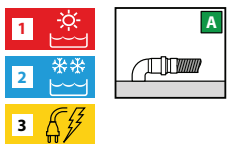

ATTENZIONE!
Può essere dannoso ai portatori di pacemakers

Installare a monte dell'apparecchio un interruttore differenziale da 30mA provvisto di interruttore onnipolare con apertura minima dei contatti ≥ 3 mm.



CARATTERISTICHE IDRAULICHE
5/7 bocchette whirlpool

Allaccio sifone con raccordo 1 1/2"



CARATTERISTICHE ELETTRICHE
Tensione 220-230 V
Frequenza 50 Hz
Potenza massima assorbita: 950 W
Whirlpool: 550 W

VENUS

VASCA ANGOLARE

Misure			Capacità	Codice		Installazione		Scelta pannelli	
Cm	H	lt.			Colonna di scarico	Sinistra	Destra	Con telaio	1 pannello
									

STANDARD CON TELAIO 										
170 x 70	55	190	101-8625-177STD	X				X	X	X
170 x 70	55	190	101-8625-177STS	X			X		X	X

HYDRO CON TELAIO SENZA DISINFEZIONE   										
170 x 70	55	190	101-8625-177HYD	X				X	X	X
170 x 70	55	190	101-8625-177HYS	X			X		X	X



FINITURA
VASCA



Bianco
lucido



FUNZIONI E DOTAZIONI

(disponibili a seconda dell'allestimento)



Massaggio corpo Whirpool (6 jets) aria/acqua con regolazione di tempo e intensità manuale o automatica. Per soddisfare qualsiasi esigenza di benessere.



Pannello di controllo con funzioni Hydro sequence



Colonna di scarico



VENUS

VENUS

VERSIONE SINISTRA

VERSIONE DESTRA

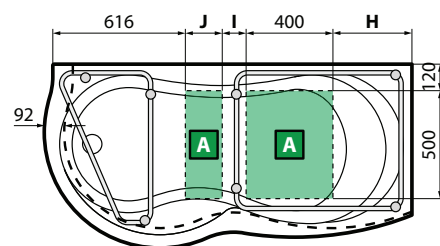
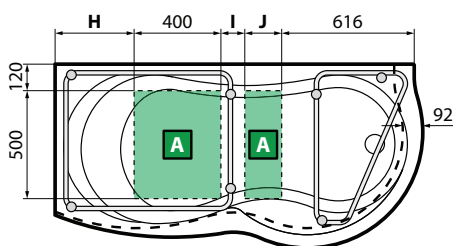
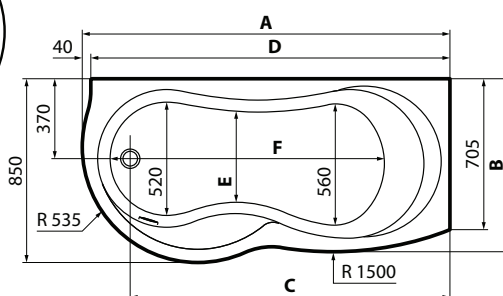
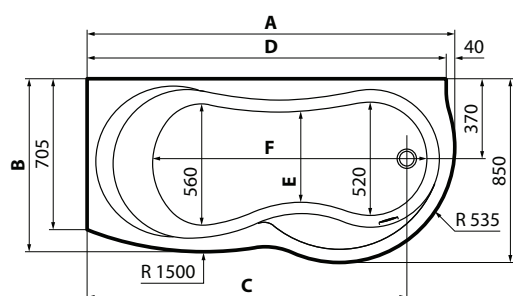
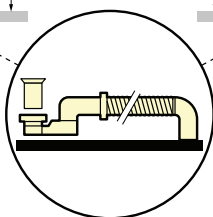
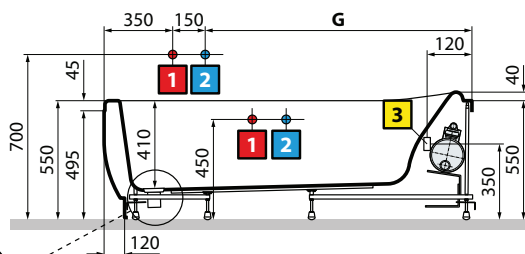
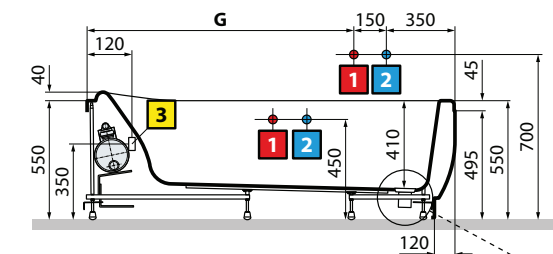

modello	A	B	C	D	E	F	G	H	I	J	Capacità litri
170x85	1700	800	1475	1660	420	1260	1200	364	110	170	190

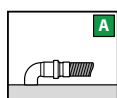

ATTENZIONE!
Può essere dannoso ai portatori di pacemakers

Installare a monte dell'apparecchio un interruttore differenziale da 30mA provvisto di interruttore onnipolare con apertura minima dei contatti ≥ 3 mm.

CARATTERISTICHE IDRAULICHE
6 bocchette whirlpool

Allaccio sifone con raccordo 1 1/2"

CARATTERISTICHE ELETTRICHE

Tensione 220-230 V
Frequenza 50 Hz
Potenza massima assorbita: 950 W
Whirlpool: 550 W